

VL

Slide Gate Valves

Flachschieber

Vannes Guillotine

Valvole a Ghigliottina

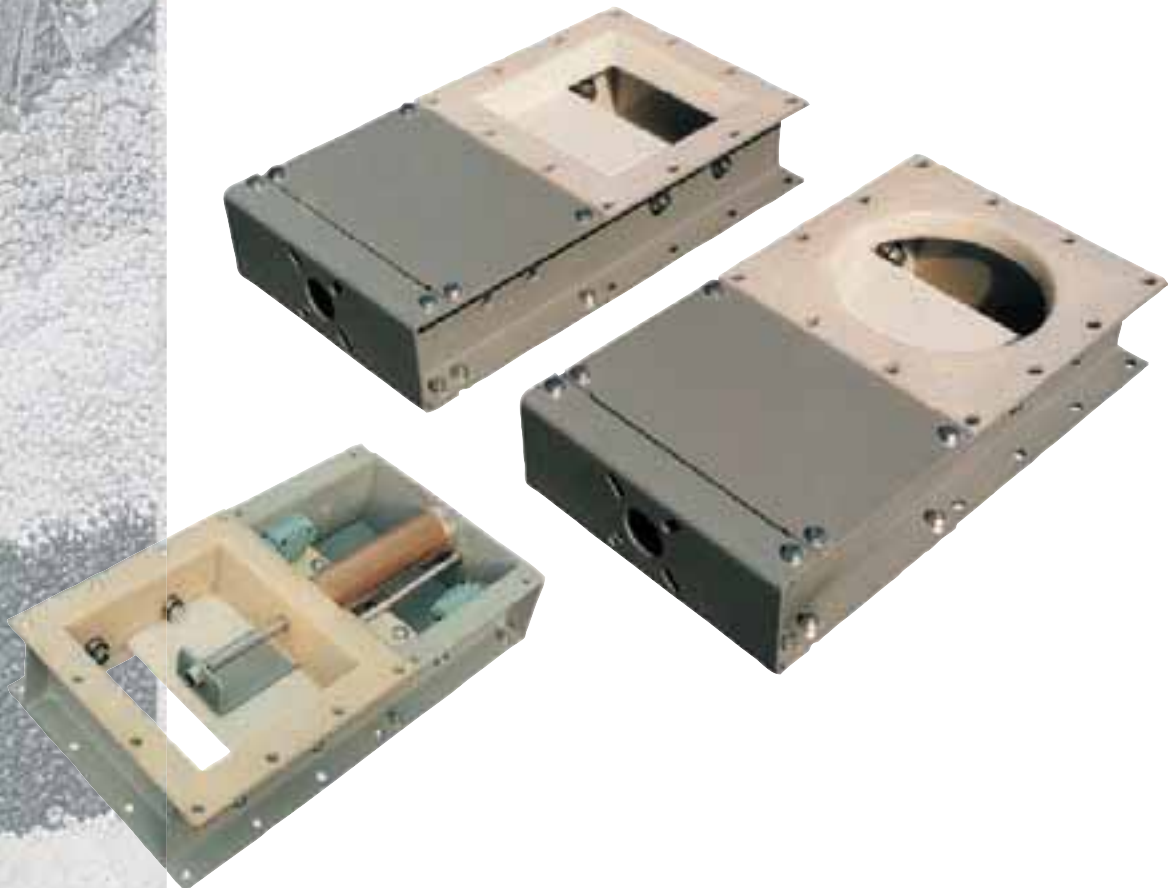

CERTIFIED



WAM®

VL Slide Valves are used where the flow of a bulk solid caused by gravity or transport has to be intercepted. Valves may be fitted to hopper or silo outlets, to the inlets and outlets of mechanical conveyors and to the inlet of telescopic loading spouts.

VL-type Slide Valves consist of a two piece carbon or stainless steel frame, which is partly coated with WAM's unique SINT® engineering polymer composite, and a sliding blade manufactured either in the same material or in stainless steel. The use of SINT® engineering polymer considerably increases resistance to abrasion compared to traditional valves.

The special geometry of the Valve and the different options of blade design enable its application in virtually every sector including the food industry.

VL-Flachschieber finden überall dort Verwendung, wo ein durch Schwerkraft oder Förderung verursachter Schüttgutfluß unterbrochen werden soll. VL-Flachschieber können unter Silo- oder Trichterausläufen, über den Einläufen bzw. unter den Ausläufen von mechanischen Steigförderern oder über dem Einlauf von Teleskop-Verladegarnituren eingebaut werden. VL-Flachschieber bestehen aus einem zweiteiligen, teilweise mit SINT®-Polymer ausgekleideten Stahl- oder Edelstahlrahmen und einem mit dem gleichen Polymer beschichteten oder aber ganz aus Edelstahl bestehenden Schieberblech. Die Verwendung von SINT®-Polymer erhöht die Abrasionsresistenz gegenüber traditionellen Flachschiebern beträchtlich.

Die spezielle Geometrie dieser Baureihe und diverse Schieberblechoptionen ermöglichen den Einsatz in allen industriellen Anwendungen inklusive der Nahrungsmittelindustrie.

Les Vannes Guillotine VL sont utilisées pour sectionner l'écoulement d'un flux de matière au vrac. Les Vannes Guillotine VL peuvent être installées sous silos ou trémies, au-dessus des bouches d'entrée et au-dessous des bouches de sortie des transporteurs mécaniques ou en tête des goulottes télescopiques.

Les Vannes Guillotine VL sont composées d'un châssis en deux parties qui est partiellement revêtu en polymère technique SINT® et d'une lame revêtue du même matériau ou entièrement en acier inox. L'utilisation de SINT® augmente considérablement la résistance à l'abrasion par rapport aux vannes de type traditionnel. La géométrie spéciale de cette gamme et les diverses options de lames rendent possible leur utilisation dans toutes les industries y compris celles de l'alimentaire.

Le Valvole a Ghigliottina VL sono utilizzate laddove un flusso di materiale alla rinfusa causato o dalla gravità o da un trasporto deve essere intercettato. Le Valvole a Ghigliottina VL possono essere installate sotto le bocche di scarico di silo o tramogge, sulle bocche di carico e scarico dei trasportatori meccanici o sulle bocche di carico degli scaricatori telescopici.

Le Valvole a Ghigliottina VL sono costituite da un telaio in due pezzi che è parzialmente rivestito del tecnopolimero SINT® e da una lama rivestita dello stesso materiale o interamente in acciaio inossidabile. L'utilizzo del SINT® aumenta considerevolmente la resistenza all'abrasione rispetto alle valvole di tipo tradizionale.

La speciale geometria di questa gamma e le diverse opzioni di lame rendono possibile la loro applicazione in tutte le industrie compresa quella alimentare.

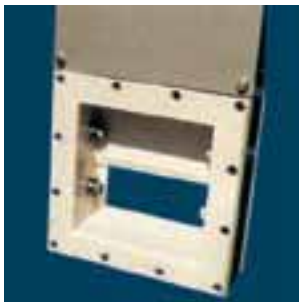

VLQ - VLR - VLS

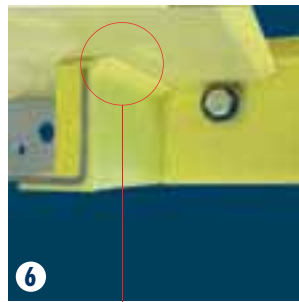

6



VLC



3 interchangeable actuators for valve types VLQ-VLC-VLR

3 Antriebsvarianten bei gleichem Schieberahmen, Typ VLQ-VLC-VLR

3 actionneurs interchangeables pour les vannes VLQ-VLC-VLR

3 attuatori intercambiabili per tipi di valvole VLQ-VLC-VLR

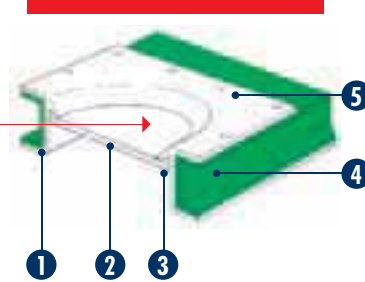
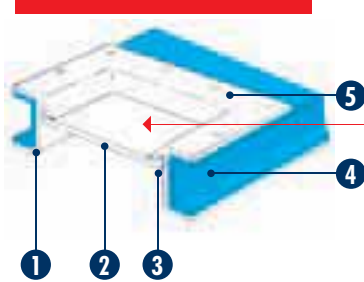

1 Valve body coated with SINT®MC or SINT®AL in order to avoid contact between product and body.

2 Heavy-duty blade (SINT®MC / SINT®AL, carbon steel, 304 st.st.)

3 Minimum friction contact

4 No additional lateral seals required

5 Dry food quality (coating in SINT®AL)

6 Dustproof (scraper included)

1 Schieberahmen komplett mit SINT®MC bzw. SINT®AL ummantelt, damit Medium niemals direkt mit dem Rahmen in Kontakt treten kann.

2 Robustes Schieberblech (SINT®MC / SINT®AL, Stahl, Edelstahl 1.4301)

3 Reibungsarmer Werkstoffkontakt

4 Keine zusätzlichen seitlichen Abdichtungen erforderlich

5 Auf Wunsch auch in nahrungsmitteltauglicher Ausführung (mit SINT®AL ummantelt)

6 Staubdicht (inkl. Abstreifer)

1 Vanne complètement revêtue en SINT®MC ou SINT®AL pour éviter le contact entre le produit et le corps.

2 Lame de forte épaisseur (SINT®MC / SINT®AL, acier au carbone, acier inox 304)

3 Résistance par friction minimum

4 Aucun système d'étanchéité supplémentaire latéral

5 Apte pour produits alimentaires secs (revêtements en SINT®AL)

6 Etanche à la poussière (muni de racleur)

1 Valvola completamente rivestita in SINT®MC o SINT®AL al fine di evitare il contatto tra il prodotto e il corpo.

2 Lama a grosso spessore con smusso per invito (SINT®MC / SINT®AL, acciaio al carbonio, AISI 304).

3 Contatto con minimo attrito

4 Tenuta laterale non necessaria

5 Idonea a prodotti alimentari secchi (rivestimento in SINT®AL)

6 Tenuta polvere (provvista di raschiatore)

User Benefits

- Easy to handle
- Ex-stock delivery
- Highly abrasion-resistant
- Easy to fit
- Time-saving maintenance

Options

- Valve manufactured in carbon steel lined and coated with SINT®MC.
- Valve in 304 stainless steel lined and coated with SINT®AL (FDA-approved)

Vorteile für den Anwender

- Einfaches Handling
- Ab Lager lieferbar
- Besonders verschleißresistent
- Einfacher Einbau
- Extrem wartungsfreundlich

Optionen

- Schieber aus Stahl, ausgekleidet mit SINT®MC.
- Schieber aus Edelstahl 1.4301, ausgekleidet mit SINT®AL (mit FDA-Zulassung)

Avantages pour l'utilisateur

- Légèreté et facilité de maintenance
- Matériel disponible en stock
- Résistance élevée à l'usure
- Facilité d'installation
- Rapidité d'entretien

Options

- Vanne en acier au carbone revêtue en SINT®MC
- Vanne en inox 304 revêtue en SINT®AL (approuvée FDA)

Vantaggi per l'utilizzatore

- Leggerezza e facilità di movimentazione
- Materiale disponibile a magazzino
- Elevata resistenza all'usura
- Facilità di installazione
- Rapidità di manutenzione

Opzioni

- Valvola in acciaio al carbonio rivestita in SINT®MC.
- Valvola in AISI 304 rivestita in SINT®AL (approvata FDA)

HAND WHEEL COMPATIBLY
KOMBINATIONSMÖGLICHKEITEN MIT HANDRAD
ACCOUPLMENTS D'ACTIONNEUR MANUEL
ABBINAMENTI DI ATTUATORE MANUALE

VLQ - VLC 0150 ..	-	CMG0150 I.
VLQ - VLC 0200 ..	-	CMG0200 I.
VLQ - VLC 0250 ..	-	CMG0250 I.
VLQ - VLR-VLC 0300 ..	-	CMG0300 I.
VLQ - VLC 0350 ..	-	CMG0350 I.
VLQ - VLC 0400 ..	-	CMG0400 I.



PNEUMATIC ACTUATOR COMPATIBLY
KOMBINATIONSMÖGLICHKEITEN MIT PNEUMATIKANTRIEB
ACCOUPLMENTS D'ACTIONNEUR ELECTROPNEUMATIQUE
ABBINAMENTI DI ATTUATORE ELETROPNEUMATICO

VLQ - VLC 0150 ..	— ● P.N. CYL. Ø 63 —	KCP 063 1525 - V5V80 - LSM6	<ul style="list-style-type: none"> • BOB 02450 • BOB 04850 • BOB 11050 • BOB 22050 △ BOB 024CC △ BOB 048CC △ BOB 110CC △ BOB 220CC
VLQ - VLC 0200 ..	— ● P.N. CYL. Ø 80 —	KCP 080 1530 - V5V80 - LSM6	
VLQ - VLC 0250 ..			
VLQ - VLR-VLC 0300 ..	— ● P.N. CYL. Ø 100 —	KCP 100 3540 - V5V40 - LSM6	
VLQ - VLC 0350 ..			
VLQ - VLC 0400 ..			



- | | | |
|------------------------|-----------------------|---------------------|
| * ALUMINIUM CASING | • ALTERNATING CURRENT | △ DIRECT CURRENT |
| * ALU-GEHÄUSE | • WECHSELSTROM | △ GLEICHSTROM |
| * CORPS EN ALUMINIUM | • COURANT ALTERNATIF | △ COURANT CONTINU |
| * CAMICIA IN ALLUMINIO | • CORRENTE ALTERNATA | △ CORRENTE CONTINUA |

● No WAM supply
Fremdfabrikat beizustellen
Hors fourniture WAM
Non forniture WAM

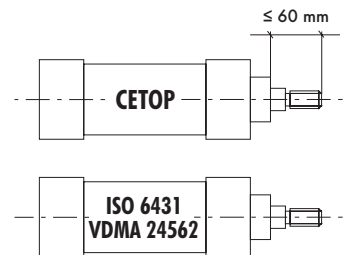

GEAR MOTOR COMPATIBLY
KOMBINATIONSMÖGLICHKEITEN MIT GETRIEBEMOTOR
ACCOUPLMENTS D'ACTIONNEUR ELECTRIQUE
ABBINAMENTI DI ATTUATORE CON MOTORIDUTTORE

VLQ - VLC 0150 ..	-	CRG010A150 I.	LSM6*
VLQ - VLC 0200 ..	-	CRG010A200 I.	
VLQ - VLC 0250 ..	-	CRG010B250 I.	
VLQ - VLR - VLC 0300 ..	-	CRG010B300 I.	
VLQ - VLC 0350 ..	-	CRG010B350 I.	
VLQ - VLC 0400 ..	-	CRG010B400 I.	

* Signalling system obligatory
Positionsanzeige erforderlich
Systeme de signalation indispensable
Sistema indispensabile di segnalazione

VLQ

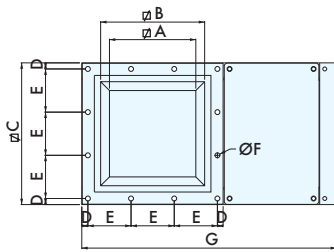

Square Cross Section Valves
Schieber mit quadratischem Querschnitt
Vannes à Section Carrée
Valvole con Sezione Quadrata



TYPE	A	B	C	D	E	N° E	Ø F	Bolts Schrauben Boulons Bulloni	G	H	kg
VLQ0150..	120	175	261	15,5	115,0	2	12,5	M10	455	113	14
VLQ0200..	170	225	311	15,5	93,3	3	12,5	M10	555	113	18
VLQ0250..	220	275	361	15,5	110,0	3	12,5	M10	650	113	22
VLQ0300..	270	325	431	23,0	128,3	3	12,5	M10	765	113	30
VLQ0350..	320	375	481	18,0	89,0	5	12,5	M10	900	125	40
VLQ0400..	370	425	531	15,5	100,0	5	12,5	M10	1.000	125	46

- 1 Carbon Steel / Stahl / Acier au carbone / Acciaio al carbonio
- 2 304 Stainless Steel / Edelstahl 1.4301 / Acier inox 304 / Acciaio inox AISI 304

VLC

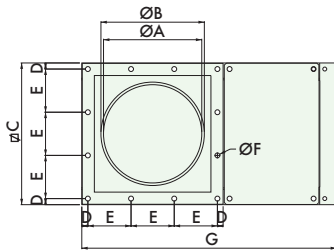

Round Cross Section Valves
Schieber mit rundem Querschnitt
Vannes à Section Circulaire
Valvole a Sezione Circolare

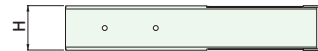

TYPE	A	Ø B	Ø C	D	E	N° E	Ø F	Screw Schrauben Boulons Bulloni	G	H	kg
VLC0150..	150	165	261	15,5	115,0	2	12,5	M10	455	113	14
VLC0200..	200	215	311	15,5	93,3	3	12,5	M10	555	113	18
VLC0250..	250	265	361	15,5	110,0	3	12,5	M10	650	113	22
VLC0300..	300	315	431	23,0	128,3	3	12,5	M10	765	113	30
VLC0350..	350	365	481	18,0	89,0	5	12,5	M10	900	125	40
VLC0400..	400	415	531	15,5	100,0	5	12,5	M10	1.000	125	46

- 1 Carbon Steel / Stahl / Acier au carbone / Acciaio al carbonio
- 2 304 Stainless Steel / Edelstahl 1.4301 / Acier inox 304 / Acciaio inox AISI 304

VLR

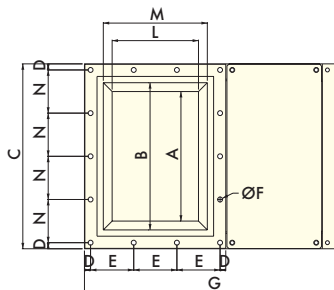

Rectangular Cross Section Valves
Schieber mit rechteckigem Querschnitt
Vannes à Section Rectangulaire
Valvole a Sezione Rettangolare

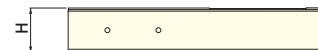

TYPE	A	B	C	D	E	N° E	Ø F	Bolts Schrauben Boulons Bulloni	G	H	L	M	N	N° N	kg
* VLR0150..	204	260	346	15,5	115,0	2	12,5	M10	455	109	119	175	105	3	18
* VLR0200..	281	337	423	15,5	93,3	3	12,5	M10	555	109	169	225	98	4	25
* VLR0250..	353	409	495	15,5	110,0	3	12,5	M10	650	109	219	275	116	4	30
VLR0300..	428	484	592	23,0	128,3	3	12,5	M10	765	109	269	325	136	4	40

- 1 Carbon Steel / Stahl / Acier au carbone / Acciaio al carbonio
- 2 304 Stainless Steel / Edelstahl 1.4301 / Acier inox 304 / Acciaio inox AISI 304

* Not yet in production / Z. Z. nicht lieferbar / Pas encore en production / Non ancora in produzione

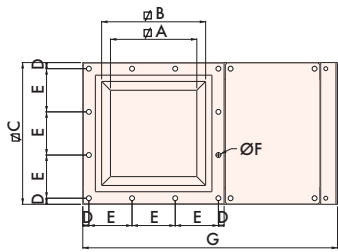

Slide Valve With Internal Actuator
 Flachschieber mit innenliegendem Pneumatiktrieb
 Vanne à Guillotine avec Vérin Incorporé
 Valvola Ghigliottina con Cilindro Interno



TYPE	A	B	C	D	E	N°E	Ø F	Bolts Schrauben Boulons Bulloni	G	H	kg
VLS0150..	120	175	261	15,5	115,0	2	12,5	M10	455	113	16,5
VLS0200..	170	225	311	15,5	93,3	3	12,5	M10	555	113	21,0
VLS0250..	220	275	361	15,5	110,0	3	12,5	M10	650	113	25,5
VLS0300..	270	325	431	23,0	128,3	3	12,5	M10	765	113	34,0

- 1 Carbon Steel / Stahl / Acier au carbone / Acciaio al carbonio
- 2 304 Stainless Steel / Edelstahl 1.4301 / Acier inox 304 / Acciaio inox AISI 304

Valve with single type of actuator (pneumatic cylinder Ø 63 mm) mounted inside the valve frame.

Schieber mit innenliegendem Pneumatiktrieb (Pneumatikzylinder Ø 63 mm) (nur ein Modell)

Vanne commandée par un seul type d'actionneur (cylindre pneumatique Ø 63 mm) monté à l'intérieur du corps.

Valvola azionata da un solo tipo di comando (cilindro pneumatico Ø 63 mm) situato internamente al corpo stesso.

Pneumatic Actuator Compatibility - Kombinationen mit Pneumatiktrieb - Accouplements électropneumatiques - Abbinamenti elettropneumatici

No headload allowed!
 Keine Schieberleibbelastung gestattet!
 Sans charge!
 Senza battente!



Valve viewed upside down
 Ansicht Schieber-Unterseite
 Vanne renversée
 Valvola rovesciata

- ALTERNATING CURRENT Δ DIRECT CURRENT
- WECHSELSTROM Δ GLEICHSTROM
- COURANT ALTERNATIF Δ COURANT CONTINU
- CORRENTE ALTERNATA Δ CORRENTE CONTINUA

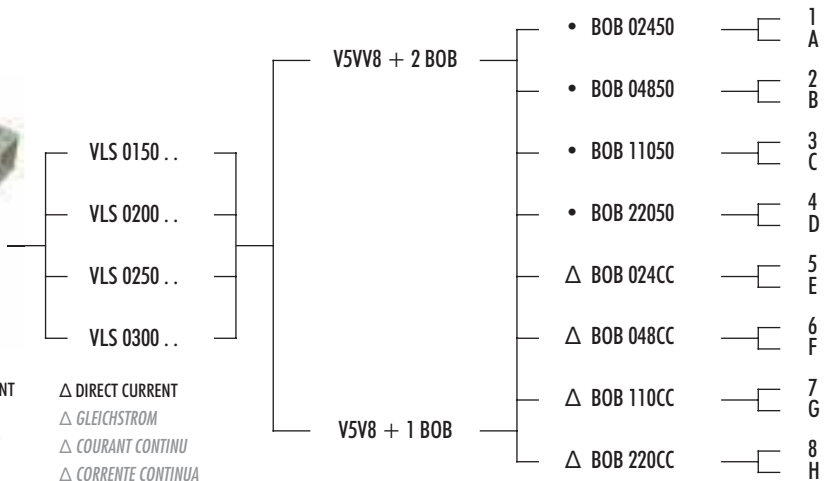



WAM S.p.A.
Via Cavour, 338
I - 41030 Ponte Motta
Cavezzo (MO) - ITALY

Tel: +39 0535 61 81 11
Fax: +39 0535 61 82 26

info@wamgroup.com
www.wamgroup.com

Further Products - Weitere Produkte - Autre production - Altra produzione

